

Industrial VPN Security Router

IVR-100 & IVR-300 Series

Quick Installation Guide

Table of Contents

1. Package Contents	3
2. Connecting The Power Input.....	4
2.1 Upper Panel	4
2.2 Wiring the Power Inputs.....	5
2.3 Grounding the Device.....	6
2.4 Wiring the Fault Alarm Contact	7
2.5 Wi-Fi Antenna Installation (IVR-300W).....	8
3. Hardware Installation	9
3.1 DIN-rail Mounting Installation.....	9
3.2 Wall-mount Plate Mounting	10
3.3 Side Wall-mount Plate Mounting.....	10
4. Setup of the VPN Gateway	11
4.1 Requirements	11
4.2 Logging in to the VPN Gateway.....	11
5. Recovering Back to Default Configuration.....	15
5.1 IP Address has been changed or admin password has been forgotten	15
6. Appendix	16
7. Customer Support	17

1. Package Contents

Thank you for purchasing PLANET Industrial Security Gateway, IVR-100 or IVR-300 series. The descriptions of these models are as follows.

IVR-100	Industrial 5-Port 10/100/1000T VPN Security Gateway
IVR-300	Industrial 5-Port 10/100/1000T VPN Security Gateway with Redundant Power
IVR-300W	Industrial 5-Port 10/100/1000T + 802.11ax Wi-Fi VPN Security Gateway
IVR-300FP	Industrial 4-Port 10/100/1000T 802.3at PoE + 1-Port 10/100/1000T + 1-Port 1000X SFP VPN Security Gateway

Open the box of the Security Gateway and carefully unpack it. The box should contain the following items:

Item	Model	IVR-100	IVR-300	IVR-300W	IVR-300FP
	VPN Gateway		x 1	x 1	x 1
QR Code Sheet		x 1	x 1	x 1	x 1
CloudViewer QIG		x 1	x 1	x 1	x 1
Wall-mount Kit		x 1	x 1	x 1	x 1
Dust Cap		x 5	x 5	x 5	x 5
SFP Cap					x 1
RS485 3-pin Terminal Block			x 1	x 1	x 1
Dual band Wi-Fi Antenna				x 2	
Antenna Dust Cap				x 2	

If any of the above items are damaged or missing, please contact your dealer immediately.

2. Connecting The Power Input

This section describes the functionalities of the VPN Gateway's components.

2.1 Upper Panel

The upper panel of the IVR-100 consists of one terminal block connector within two DC power inputs.

Figure 2-1 shows the upper panel of the IVR-100 VPN Gateway.

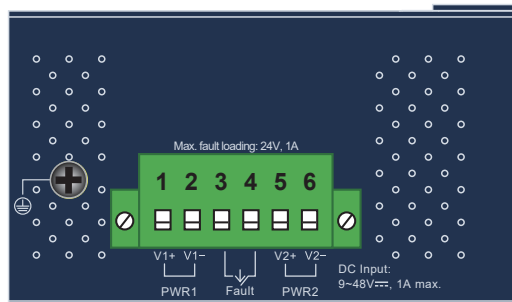

Figure 2-1: IVR-100 Upper Panel

The Upper Panel of the IVR-300 series consists of two terminal block connectors.

- Green terminal block connector: Power 1, Power 2 input and relay alarm output
- Yellow terminal block connector: 2 digital input and 2 digital output

Figure 2-2 shows the upper panel of the IVR-300/IVR-300W VPN Gateway.

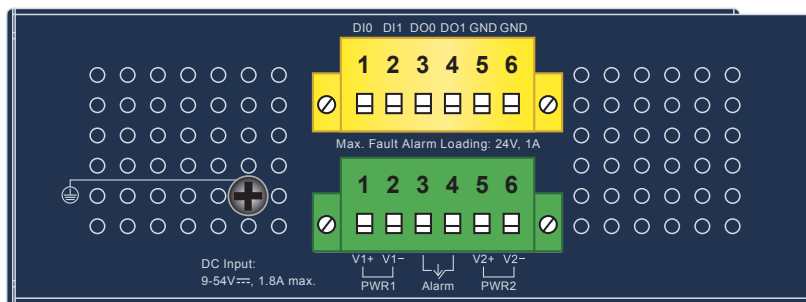

Figure 2-2: IVR-300/IVR-300W Upper Panel

The Upper Panel of the IVR-300FP series consists of two terminal block connectors.

- Green terminal block connector: Power 1, Power 2 input and relay alarm output
- Yellow terminal block connector: 2 digital input and 2 digital output

Figure 2-3 shows the upper panel of the IVR-300FP VPN Gateway.

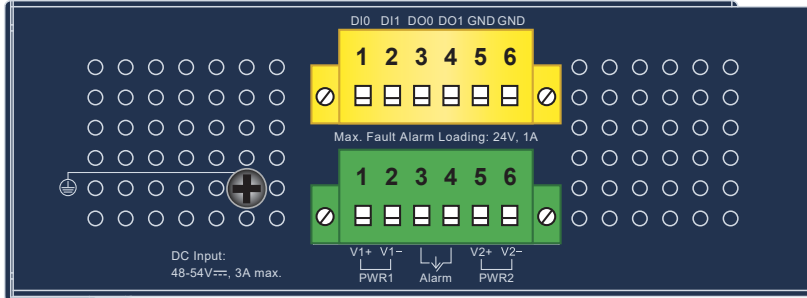

Figure 2-3: IVR-300FP Upper Panel

2.2 Wiring the Power Inputs

The 6-contact terminal block connector on the top panel of VPN Gateway is used for two redundant power inputs. Please follow the steps below to insert the power wire.



Caution

When performing any of the procedures like inserting the wires or tightening the wire-clamp screws, make sure the power is OFF to prevent from getting an electric shock.

1. Insert positive and negative DC power wires into contacts 1 and 2 for POWER 1, or 5 and 6 for POWER 2.

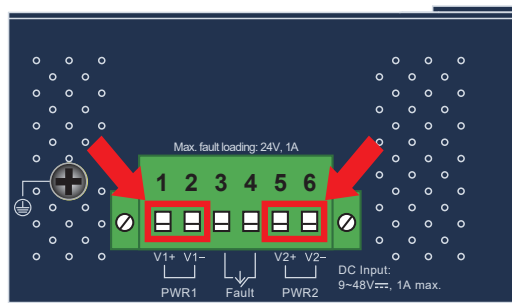

Figure 2-4: Power 1 and Power 2



Note

Please make sure the input voltage is under the specification of the Security Gateway.

2. Tighten the wire-clamp screws for preventing the wires from loosening.

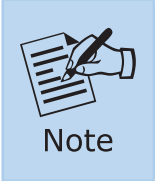
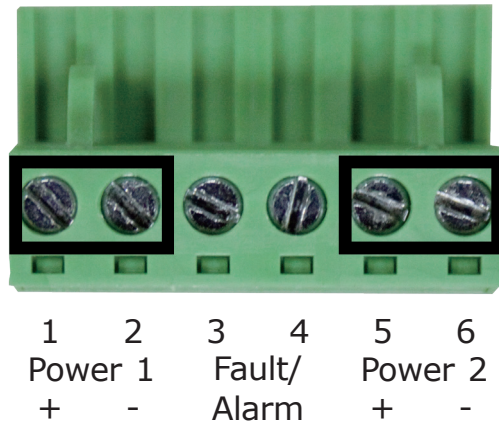

The wire gauge for the terminal block should be in the range between 12 and 24 AWG.



PWR1 and PWR2 must provide the **same DC voltage** while operating with dual power input.

2.3 Grounding the Device

User **MUST** complete grounding wired with the device; otherwise, a sudden lightning could cause fatal damage to the device.

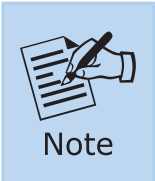
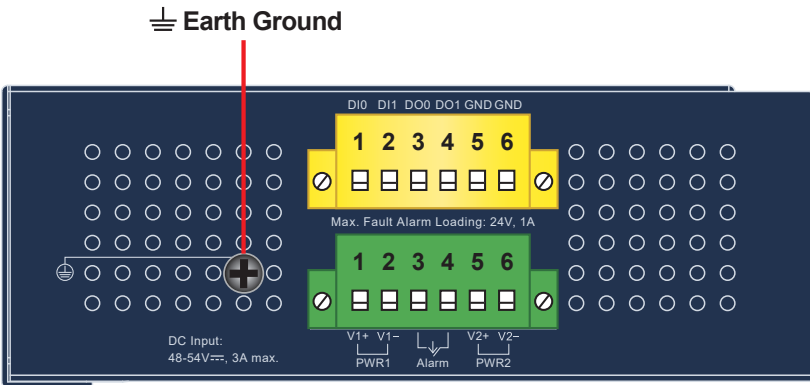

EMD (Lightning) DAMAGE IS NOT COVERED UNDER WARRANTY.

2.4 Wiring the Fault Alarm Contact

The fault alarm contacts are in the middle of the terminal block connector as the picture shows below. Inserting the wires, the Security Gateway will detect the fault status of the power failure or port failure, and then will form an open circuit. The following illustration shows an application example for wiring the fault alarm contacts.

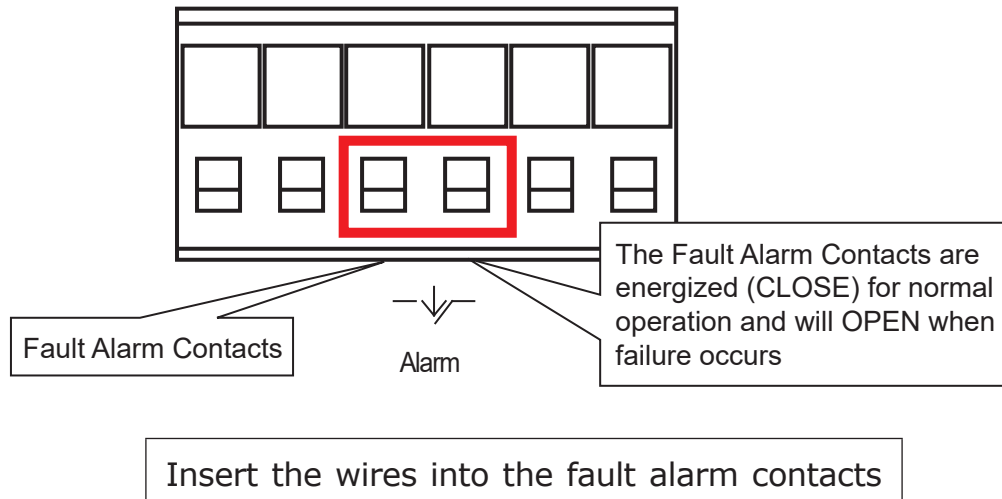

Note

1. The wire gauge for the terminal block should be in the range between 12 and 24 AWG.
2. Alarm relay circuit accepts up to 24V, max. 1A currents.

2.5 Wi-Fi Antenna Installation (IVR-300W)

Step 1: Fasten the two dual-band antennas to the antenna connectors on the front panel of the IVR-300W.

Step 2: You can bend the antennas to fit your actual needs.

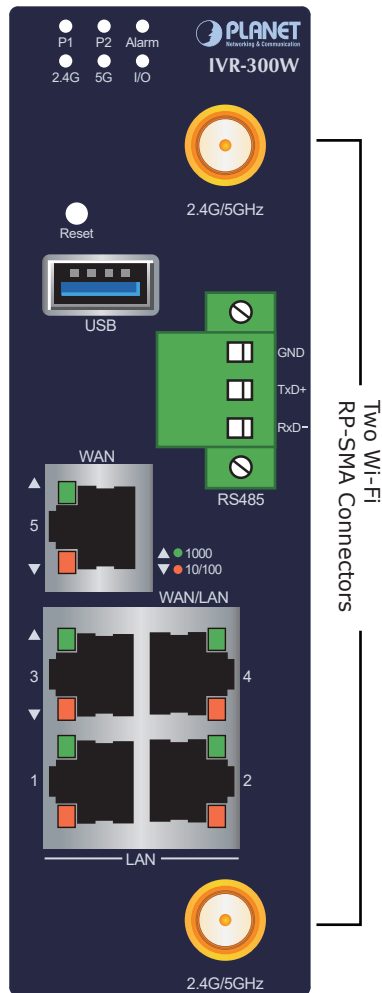

Figure 2-5: IVR-300W Front Panel

3. Hardware Installation

This section guides you to installing the VPN Gateway on the DIN-rail and wall. Basic knowledge of networking is assumed. Please read this chapter completely before continuing.



Note

The installation procedures of the IVR-100 & IVR-300 series are the same as the ones shown below.

3.1 DIN-rail Mounting Installation

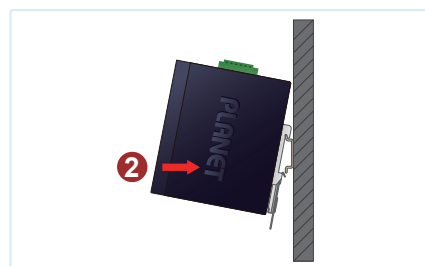
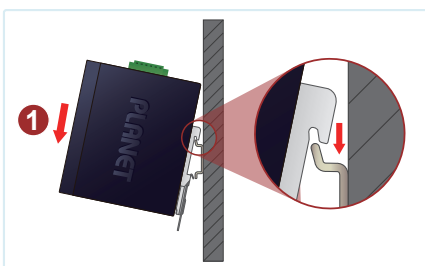
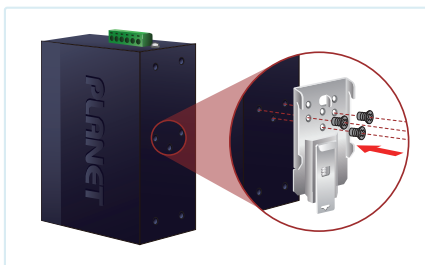
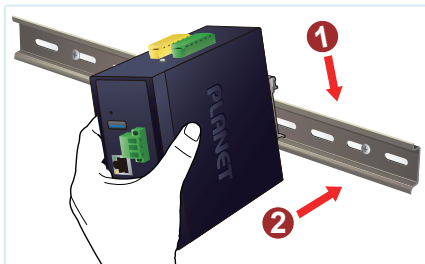
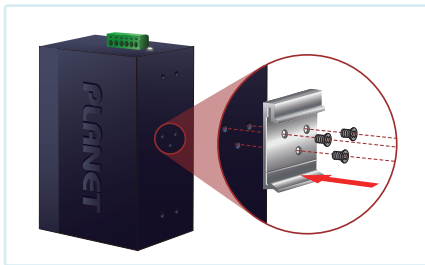

3.2 Wall-mount Plate Mounting

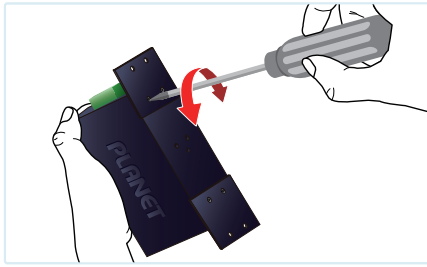

3.3 Side Wall-mount Plate Mounting

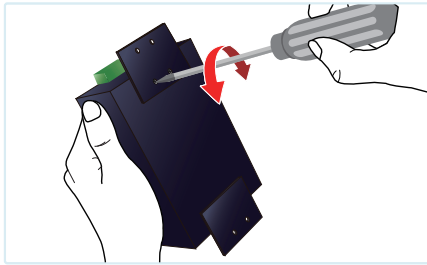

Caution

You must use the screws supplied with the wall-mounting brackets. Damage caused to the parts by using incorrect screws would invalidate your warranty.

4. Setup of the VPN Gateway

4.1 Requirements

Please confirm the following items before configuration:

1. Test your network connection by connecting your computer directly to ISP.
2. Suggested operating systems: Windows 7/8/10/11, macOS 10.12 or later, Linux Kernel 2.6.18 or later, or other modern operating systems that are compatible with TCP/IP Protocols.
3. Recommended web browsers: Google Chrome, Microsoft Edge or Mozilla Firefox.

4.2 Logging in to the VPN Gateway

Then refer to the steps below to configure the VPN Gateway:

Step 1: Connect the IT administrator's PC and VPN Gateway's LAN port (port 1) to the same hub/switch, and then launch a browser to link the management interface address which is set to **https://192.168.1.1** by default.

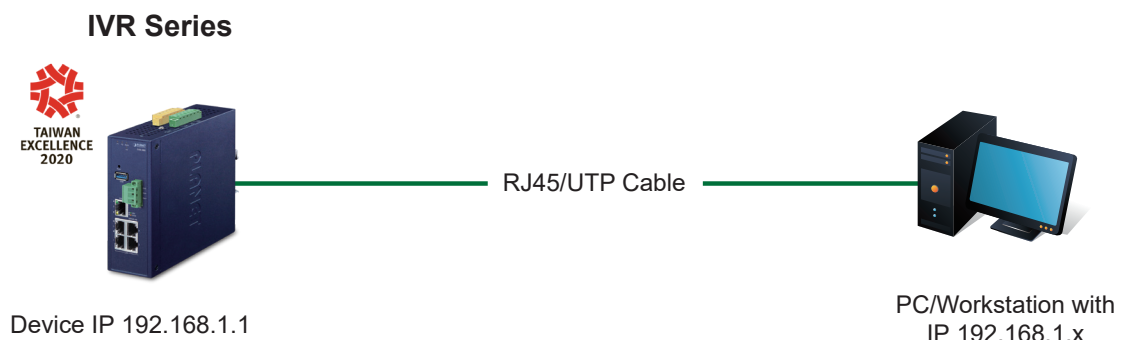

Figure 4-1: IP Management Diagram



Note

The DHCP server of the VPN Gateway is enabled. Therefore, the LAN PC will get IP from the VPN Gateway. If user needs to set IP address of LAN PC manually, please set the IP address within the range between 192.168.1.2 and 192.168.1.254 inclusively, and assign the subnet mask of 255.255.255.0.



Note

The following steps is based on the firmware version before **August of 2024**.

Step 2a: The browser prompts you for the login credentials. (Both are “**admin**” by default.)

Default IP address: 192.168.1.1
Default user name: **admin**
Default password: **admin**
Default 2.4GHz SSID: **PLANET_2.4G (for IVR-300W)**
Default 5GHz SSID: **PLANET_5G (for IVR-300W)**

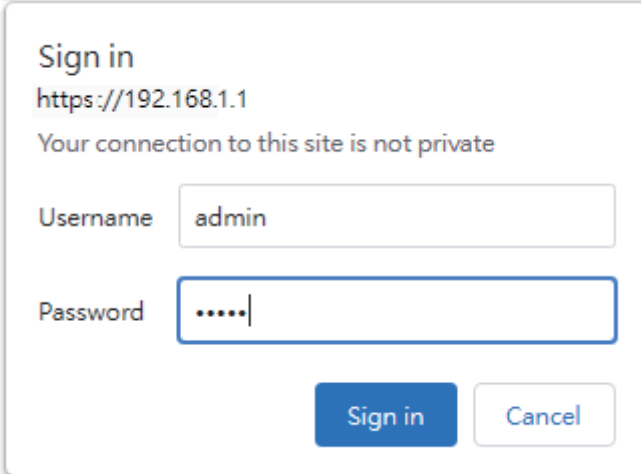

Sign in
https://192.168.1.1
Your connection to this site is not private

Username

Password

Figure 4-2: Web Login Screen



Note

The following step is based on the firmware version of **August of 2024 or after**.

Step 2.b: The browser prompts you for the login credentials.

Default IP address: 192.168.1.1
Default user name: **admin**
Default password: **cg + the last 6 characters of the MAC ID in lowercase**
Default 2.4GHz SSID: **PLANET_2.4G (for IVR-300W)**
Default 5GHz SSID: **PLANET_5G (for IVR-300W)**

When Login dialog box appears, please enter the default user name and password. Refer to Figure 4-3 to determine your initial login password. Default IP address is **192.168.1.1**, default username is **admin** and default password is **cg + the last 6 characters of the MAC ID in lowercase**.

Find the MAC ID on your device label. The default password is "cg" followed by the last six lowercase characters of the MAC ID.

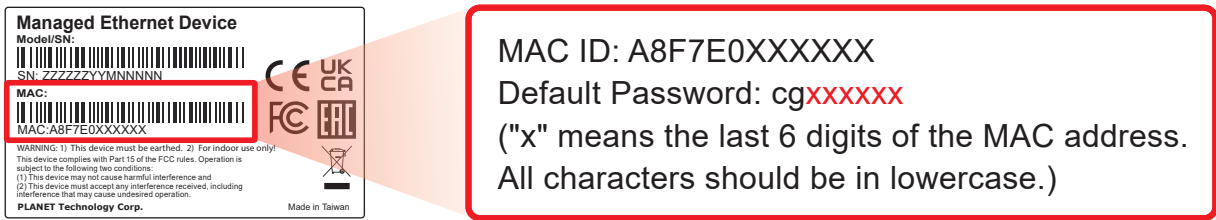
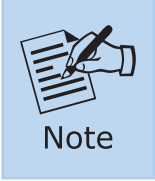

Figure 4-3: MAC ID Label



The following web screen is based on the IVR-300W; the displays of the IVR-100 and IVR-300 are the same as that of the IVR-300W.

Please follow the wizard to do the first-time account modification.

The password must contain 8 to 31 characters, including upper case, lower case, numerals and other symbols shown in **Figure 4-4**.

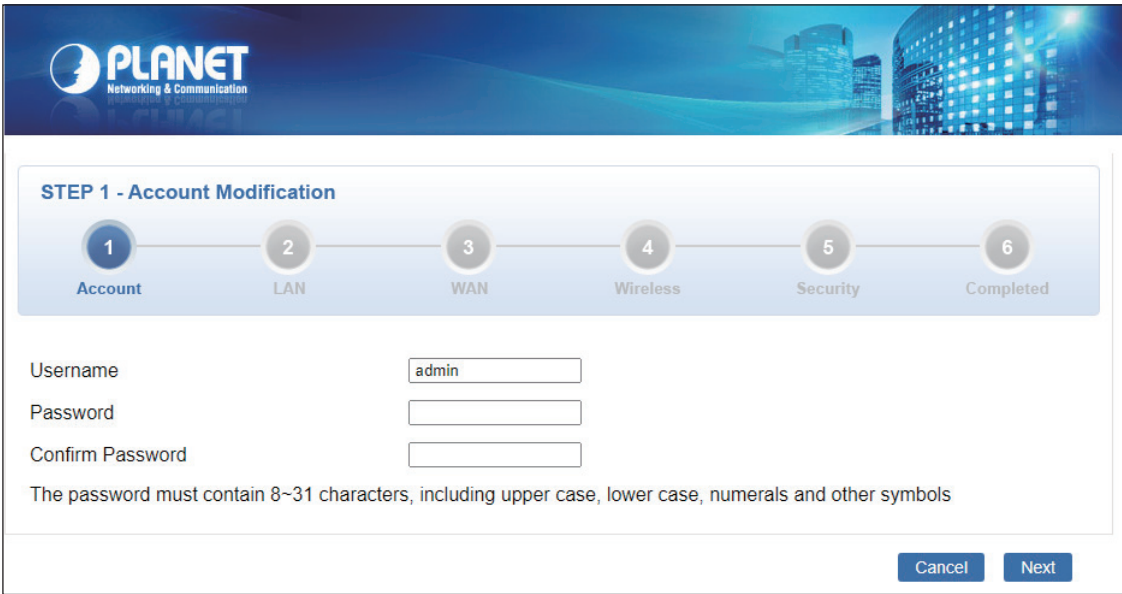

Figure 4-4: Account Modification

After modifying the new account and password, the main screen appears as shown in Figure 4-5.

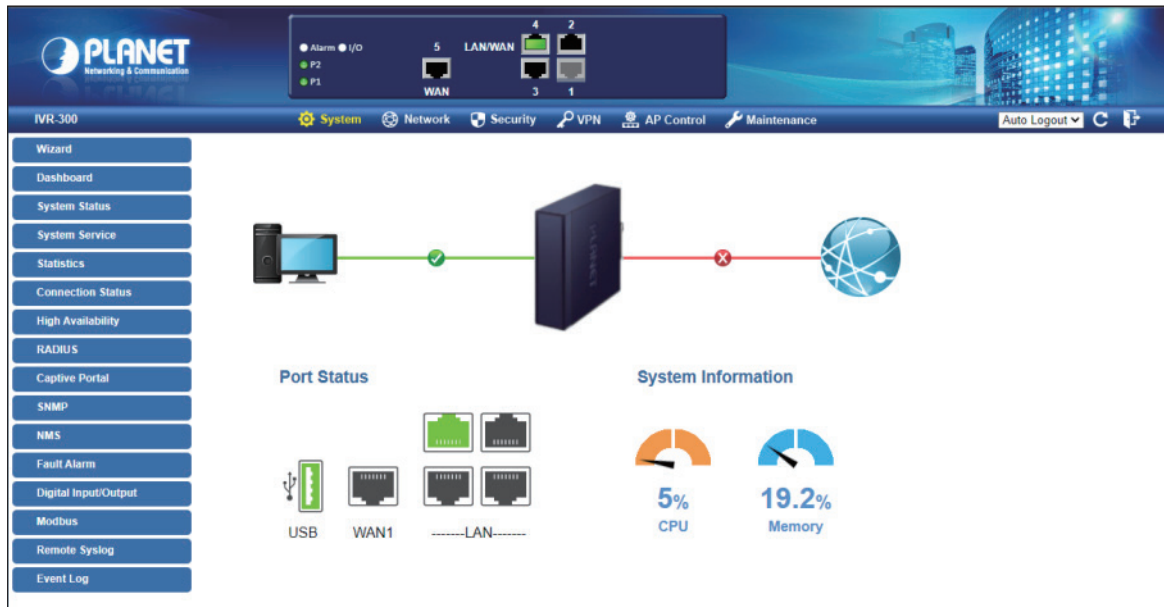

Figure 4-5: Web Main Screen

Now, you can use the Web management interface to continue the Security Gateway management or manage the Security Gateway by console interface. Please refer to the user's manual for more.

Administrators are strongly suggested to change the default password and Wi-Fi SSID on the first login to safeguard system security.



Note

1. For security reason, **please change and memorize the new password after this first setup.**
2. Only accept command in lowercase letter under web interface.

5. Recovering Back to Default Configuration

5.1 IP Address has been changed or admin password has been forgotten –

To reset the IP address to the default IP address “**192.168.1.1**” or reset the login password to default value, press the hardware **reset button** on the front panel for about **10 seconds**. After the device is rebooted, you can log in the management Web interface within the same subnet of 192.168.1.xx.

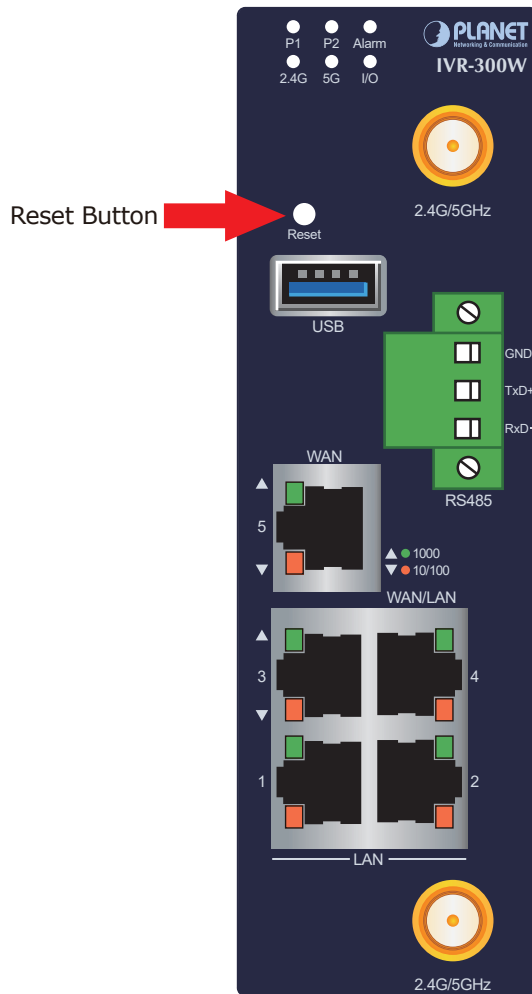

Figure 5-1: Reset Button of IVR-300 Series





Note

The location of the reset button is the same for all the IVR-300 series.

6. Appendix

Appendix A: Default Setting	
Default IP Address	192.168.1.1
Default Login User Name	admin
Default Login Password	Depends on the firmware version. Please refer to Chapter 4 for details.
Default DHCP Server	On
Default LAN Port	Ethernet Ports 1-4
Default WAN Port	Ethernet Port 5
Default 2.4G SSID (for IVR-300W)	PLANET_2.4G
Default 5G SSID (for IVR-300W)	PLANET_5G

Appendix B: User's Manual		
	IVR-100	IVR-300 series
User's Manual		

7. Customer Support

Thank you for purchasing PLANET VPN Gateway. The above steps introduce the simple configuration of the VPN Gateway. If you have other questions, please contact the local dealer where you purchased this product or you can contact PLANET directly at the following email address:

support@planet.com.tw.

PLANET online FAQs:

<https://www.planet.com.tw/en/support/faq>

Copyright © PLANET Technology Corp. 2024.

Contents are subject to revision without prior notice.

PLANET is a registered trademark of PLANET Technology Corp.

All other trademarks belong to their respective owners.